

AnalogMAX



Full-featured Sensor Fusion FPGA Board with Smoke and Aerosol Detection

Developed in association with Arrow Electronics and Trezz Electronic GmbH, the AnalogMAX is a full-featured sensor fusion FPGA board based on the Intel® MAX® 10 FPGA and Analog Devices' new ADPD188BI integrated optical module for smoke and aerosol detection.

The ADPD188BI is a complete photometric system for smoke and aerosol detection that utilizes optical dual-wavelength technology. The chip integrates a highly efficient photometric front end, two LEDs and a photodiode.

AnalogMAX also features a fully calibrated, single-chip temperature sensor (0.25°C, 16-bit), MEMs accelerometer (3-axis), and 8 channel, 12-bit, configurable ADC/DAC/GPIO with on-chip reference.

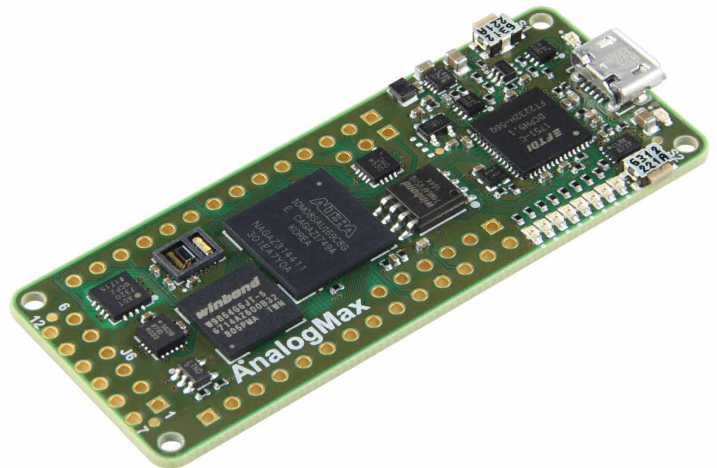

> Features

- ADPD188BI integrated optical module for smoke and aerosol detection
- Intel MAX 10 FPGA
- AD5592R configurable ADC/DAC/GPIO with on-chip reference
- ADT7320 0.25°C accurate, 16-bit temperature sensor
- ADXL362 3-axis acceleration sensor
- LTC1799 silicon oscillator for clocking
- Power Supply by Analog Devices, DC/DC LT8607, LDO ADP160
- PMOD and MKR for optional expansion boards
- Pre-programmed demo application
- Customized board available for real world products!

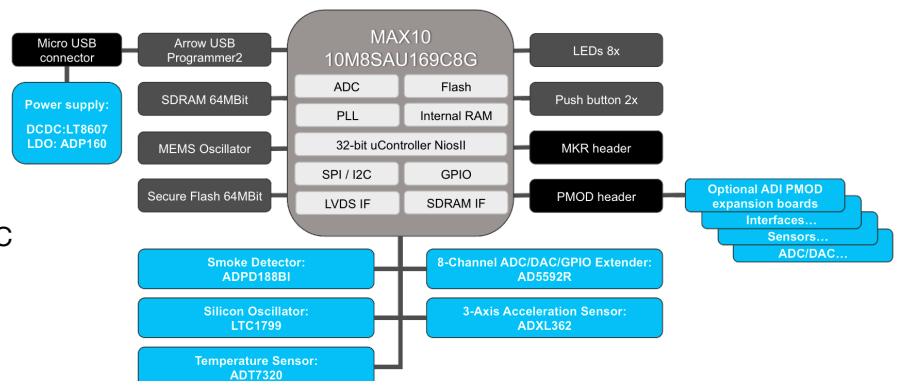

Featured Products

> ADPD188BI - OPTICAL MODULE FOR SMOKE AND AEROSOL MONITORING

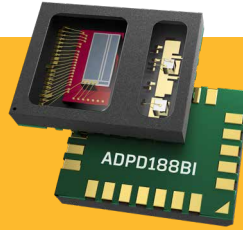

- > Complete optical solution in a tiny module ideal for:
 - Residential and commercial smoke detection
 - Pollution monitoring
 - Aerosol detection

- > Meets UL217Rev. 8 and other agency requirements
- > Enables more design and integration options, including chamberless designs
- > Eases assembly flows and supply chain management
- > Companion evaluation tool also available (EVAL-ADPD188BIZ-SK)

Additional Products from Analog Devices enabling Arrow's AnalogMAX-01:

ADI Sensors:

- > **ADPD188BI** - Integrated Optical Module for Smoke and Aerosol Detection
- > **ADT7320** - $\pm 0.25^{\circ}\text{C}$ Accurate, 16-Bit Digital SPI Temperature Sensor
- > **ADXL362** - Micropower, 3-Axis, $\pm 2\text{ g}/\pm 4\text{ g}/\pm 8\text{ g}$ Digital Output MEMS Accelerometer.

ADI Clock and Data Conversion:

- > **LTC1799** - 1kHz to 33MHz Resistor Set SOT-23 Oscillator
- > **AD5592R** - 8 Channel, 12-Bit, Configurable ADC/DAC with on-chip Reference, SPI interface

ADI POWER:

- > **LT8607** - 42V, 750mA Synchronous Step-Down Regulator with $2.5\mu\text{A}$ Quiescent Current
- > **ADP160** - Ultra Low Quiescent Current 150 mA, CMOS Linear Regulator

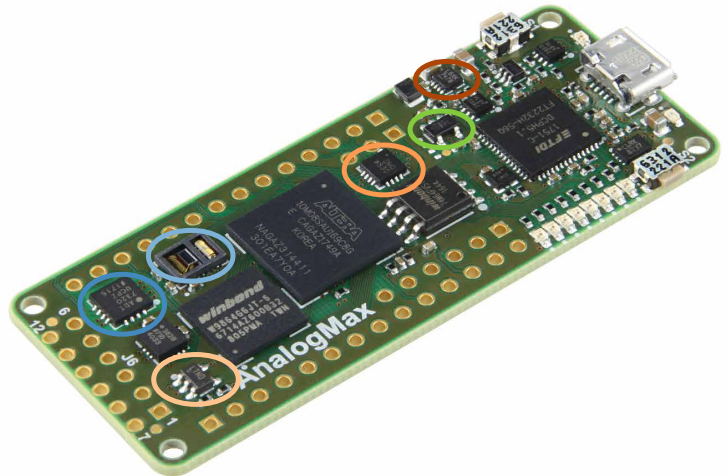

Total ADPD188BI Optical Module Data

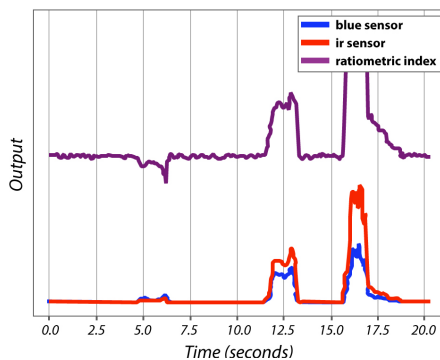

Included with AnalogMAX:

- > Full featured Sensor Fusion FPGA board
- > Demonstrations / development examples

The AnalogMAX is a full featured sensor fusion FPGA board that includes a number of sensor specific demonstrations which permit out-of-the-box data collection as well as a starting point to develop your sensor environment.

- > ADXL362 Accelerometer Demonstration
- > ADT7320 Temperature Demonstration
- > AD5592R 8 Channel ADC/DAC/GPIO Demonstration
- > ADPD188BI Integrated Optical Module for Smoke & Aerosol Detection Demonstration

```
In [1]: #
# AnalogMax: Smoke Sensor Demo
#
%matplotlib notebook

import serial
import numpy as np
from matplotlib import pyplot as plt
from time import time
#
# Please change here to proper COM port name
#
ser = serial.Serial('COM5', 115200)
#
# ADPD register access functions
#
def ADPD_write_reg(reg, value):
    ser.reset_input_buffer() #
    cmd = "<8K%0.2xK%0.2xK%" % (reg, (value >> 8), (value & 0xFF)) #
    ser.write(bytearray(cmd, 'utf8')) # Send command, REG and value

def ADPD_read_reg(reg):
    ser.reset_input_buffer() #
    cmd = "<8K%0.2xK<c9K..m..M%" % reg #
    ser.write(bytearray(cmd, 'utf8')) # Send command, R
    s = ser.read(4)
    return int(s, 16)

def ADPD_read_fifo():
    fifoLevel = ADPD_read_reg(0x00) >> 8
    # Do something if fifo level < 2 ?
    retval = ADPD_read_reg(0x60)
    retval = 1 - retval / 255
```

Total ADPD188BI Optical Module Data

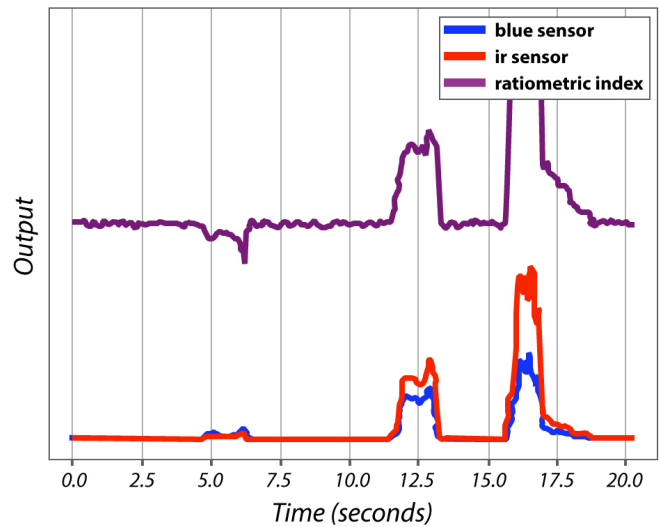

AnalogMAX includes documentation and four demonstrations to highlight data capture options. They were created in Jupyter notebooks so you can easily make modifications to the data capture and display demonstrations while jumpstarting your design activity. As you learn more you can experiment with the combination of these sensors and algorithm development across a wide range of application scenarios.

AnalogMAX Sensor Fusion FPGA Development Platform Documentation

To understand how you can use the AnalogMAX development platform, review the **Online Documentation** <https://wiki.trenz-electronic.de/display/PD/TEI0010+TRM>



AnalogMAX ADXL362 Accelerometer Demonstration

The AnalogMAX contains an ADXL362 3-axis MEMS digital accelerometer. The AnalogMAX Accelerometer Demonstration is written in Python and accesses the ADXL362 via its SPI interface by way of the NIOS II soft core processor internal to the MAX10 FPGA. A custom USB host driver is used to permit host to AnalogMAX communications. The driver download information can be found in the AnalogMAX User Guide.

The Python code is executed within a Jupyter notebook file. This code is for example purposes only and is not intended to demonstrate a final product application. The Python code writes and reads from the ADXL362 device registers and plots the SPI data output. Tilting the AnalogMAX board while plotting the output applies the necessary stimulus to the accelerometer for the demonstration. Adjustments to the plotting time and other variables can be easily adjusted by revising the appropriate Python code



AnalogMAX ADT7320 Temperature Demonstration

The AnalogMAX contains an ADT7320 16-bit digital temperature sensor. The sensor is accurate to within +/- 0.25 degrees C and has an ultralow drift characteristic.

The AnalogMAX ADT7320 Temperature Demonstration is written in Python and accesses the ADT7320 via its SPI interface by way of the NIOS II soft core processor internal to the MAX10 FPGA. A custom USB host driver is used to permit host to AnalogMAX communications. The driver download information can be found in the AnalogMAX User Guide.

The Python code is executed within a Jupyter notebook file. This code is for example purposes only and is not intended to demonstrate a final product application. The Python code writes and reads from the ADT7320 device registers and plots the SPI data output. Applying cold spray or a heat source such as a blow dryer or heat gun will cause changes in temperature to be plotted for the demonstration. Adjustments to the plotting time and other variables can be easily adjusted by revising the appropriate Python code.



AnalogMAX AD5592R 8 Channel ADC/DAC/GPIO Demonstration

The AnalogMAX contains an AD5592R 8-channel combination ADC/DAC/GPIO device. The eight channels are multiplexed between the ADC, DAC, and GPIO functions. All eight channels can be independently configured as either an ADC input, DAC output, or GPIO function.

The AnalogMAX AD5592R Demonstration is written in Python and accesses the combination device via its SPI interface by way of the NIOS II soft core processor internal to the MAX10 FPGA. A custom USB host driver is used to permit host to AnalogMAX communications. The driver download information can be found in the AnalogMAX User Guide.

The Python code is executed within a Jupyter notebook file. This code is for example purposes only and is not intended to demonstrate a final product application. External stimuli are required to excite the ADC and GPIO inputs if so configured. The connections to these inputs as well as the DAC outputs are shared. These connections are made via the header locations on the sides of the board. Please refer to the User Guide for details.

The Python code writes and reads from the AD5592R device registers and plots the SPI data output. The plotting time and other variables can be easily adjusted by revising the appropriate Python code.

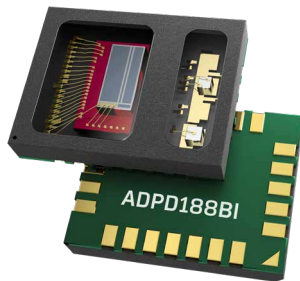

AnalogMAX ADPD188BI Integrated Optical Module for Smoke & Aerosol Detection Demonstration

The AnalogMAX contains an ADPD188BI integrated optical module which can detect smoke and aerosol particulates. The module integrates a highly efficient photometric front end, two light emitting diodes (LEDs), and two photodiodes (PDs). These items are housed in a custom package that prevents light from going directly from the LED to the photodiode without first entering the particulate detection chamber. The front end of the application specific integrated circuit (ASIC) consists of a control block, a 14-bit analog-to-digital converter (ADC) with a 20-bit burst accumulator, and three flexible, dependently configurable LED drivers. The control circuitry includes flexible LED signaling and synchronous detection. The LED/PD pair must be calibrated for power transfer match between the two channels before use.

The optical module does not generate a smoke/aerosol concentration value directly. The blue channel is sensitive to larger sized particulates. The IR channel is sensitive to smaller sized particulates. Comparing the two outputs to each other along with other time variant variables yields the final measurement. The Python code plots each raw channel output and the ratio between the two. Further algorithm development is required to produce a true smoke/aerosol measurement.

The ADPD188BI uses an I2C interface to communicate with the NIOS II soft core processor embedded in the MAX10 FPGA. A custom USB host driver is used to permit host to AnalogMAX communications. The driver download information can be found in the AnalogMAX User Guide.

The Python code is executed within a Jupyter notebook file. This code is for example purposes only and is not intended to demonstrate a final smoke/aerosol detection product. External stimuli such as smoke detector test spray, or even tapping one's finger on the sensor face will produce a raw data plot. Adjustments to the plotting time and other variables can be accomplished by revising the appropriate Python code

Via Phone

Contact your local Arrow representative at:

North America +1 855 326 4757

Europe, Middle East, & Africa
+44 20 3936 5486

Asia-Pacific +86 400 920 0628

Online

arrow.com

www.arrow.com/analogmax