



Charge Control Methods for SuperCapacitors

Methods to Protect Power Sources from Damage Due to High Current Demands of SuperCapacitors

By: Ron Demcko, Joe Hock, Ashley Stanziola, and Daniel West
AVX Corporation
One AVX Blvd
Fountain Inn, SC 29644
www.avx.com

Introduction

Circuit designs exploiting the increased energy storage provided by supercapacitors, requires careful consideration of the increased power handling, than that of batteries, when charging these devices. The unique composition of electrochemical double-layer capacitors (EDLC) inherently allows them to withstand large currents. Table 1 below is a brief list of AVX cylindrical (SCC) and series-connected module (SCM) SuperCapacitors, displaying peak current supply and sink current capability. These maximum specifications will typically exceed current capability of charge sources, and lead to failures within the power supply system.

AVX Capacitor Series	MAX Capacitance	Voltage Rating	MAX Peak Current
SCC	3000 F	2.7 V	2165 A
SCM	15 F	5.4 V	23.5 A
16V SCM	500 F	16 V	1900 A
48V SCM	165 F	48 V	2165 A

Table 1. Supercapacitor capability to sink & supply current

Supercapacitors have low ESR causing an uncharged supercapacitor to appear as a dead short, this will instantaneously draw maximum current from the source in an attempt to charge up to its rated capacitance[$I = C \times (dV/dt)$]. Typically, this charge current greatly eclipses what the power source is able to supply. In many instances, the amount of current draw is so much more than what the power supply can handle, that it will drive the power source or system into permanent failure or at least a transient upset. To demonstrate this, compare the current draw by a supercapacitor to a transient containing hundreds or thousands of amps, causing significant voltage drop across sensitive circuits resulting in bit error on high-speed transceivers, system shutdown, or software reset. In an effort to mitigate this problem, many charge limiting circuits exist, but a high level comparison of passive and active control methods can help determine which topology to implement.

Passive Charge Control Method: Fixed Resistor VS Thermistor

Resistor

One option for a passive current limiter, is to add a fixed resistor in series to the supercapacitor. The added resistance will lower the inrush current to a desired value. Even though this solution is easy to design, it is important to know that a fixed resistor will degrade the power supply and cause power loss. The power equation, shown below, demonstrates how a resistor can affect the power in a system. Another important design consideration is the efficiency of a fixed resistor solution. Since there is a significant amount of power loss, a fixed resistor will be less efficient than other current limiters.

$$P = I^2R$$

Where:

- P=Power
- I=Current
- R=Resistance

Figures 1, 2, and 3 are spice simulations to show how fixed resistors limit inrush current. When a 10F supercapacitor is connected to a 2.7V source, there is an immediate 27A inrush current (Figure 1). Adding a series 150Ω resistor, the inrush current drops to 18mA (Figure 2). Adding a 10KΩ drops the inrush current to 280μA (Figure 3). To find the desired resistance, a simple Ohm's law equation is used; where I is the peak inrush current.

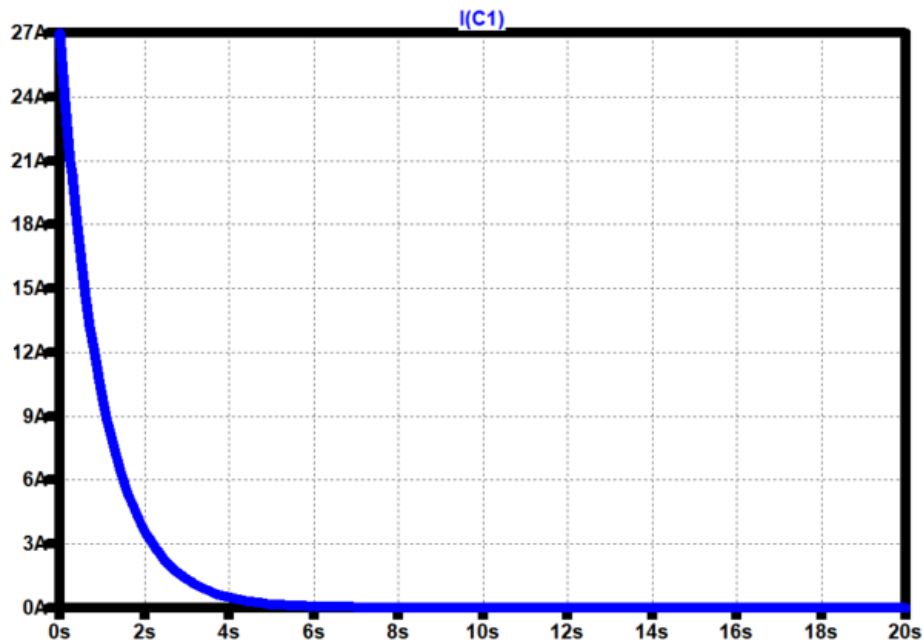

Figure 1: Spice simulation of a 10F supercapacitor without a series resistor

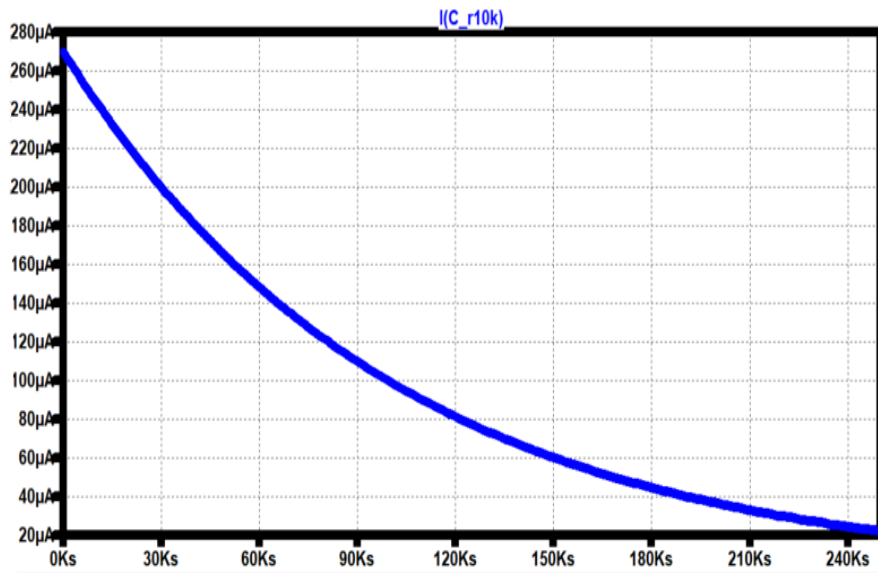

Figure 2: Spice simulation of 10F supercapacitor with a 10KΩ series resistor

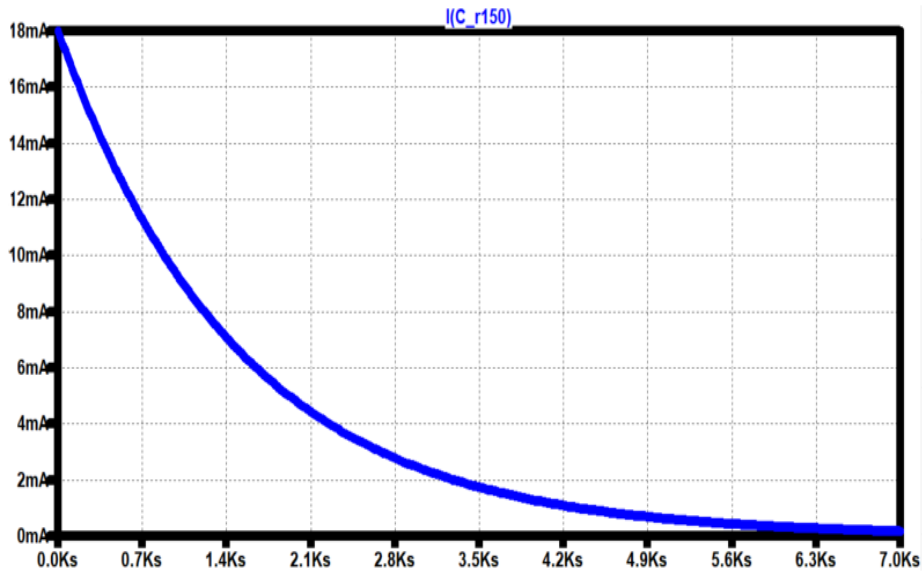

Figure 3: Spice simulation of 10F supercapacitor with a 150Ω series resistor

Thermistor

Another option for a passive current limiter is to replace the fixed resistor solution with a series Negative Temperature Coefficient (NTC) resistor, also known as a thermistor. An NTC is similar to a fixed resistor while at 25°C. The difference is that an NTC varies resistance in accordance to a Non-linear curve that is temperature dependent, see Figure 4 below. At 25 °C, the thermistor starts with a defined high

resistance state, absorbing power and restricting inrush current. As the system runs, the load draws current and the NTC will heat up. When the NTC is heated, the resistance value will drop in accordance to its performance curves. With a lesser resistance, more current will flow into the supercapacitor. The effect of an NTC body temperature related to the current flowing into the load, shown in Figure 5 below.

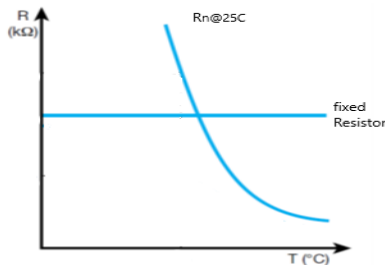

Figure 4: Fixed resistor and NTC Thermistor Response Vs Temperature

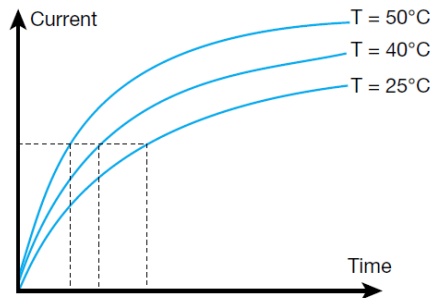

Figure 5: The effect of NTC body Temperature upon current flow through the NTC

The top section of Figure 6, is a Spice simulation that shows how the NTC ($R_{150@25C}$) resistance decreases over time. The bottom portion of Figure 6, is a Spice simulation to show how the NTC controls the inrush current. As stated earlier, when a 10F capacitor is connected to 2.7V, the inrush current is 27A. When a NTC $R_{150@25C}$ is added in series, there is an inrush current of 18mA. Comparing Figure 6 with a 150Ω fixed resistor, previously shown in Figure 3, it is clear that the inrush current is limited to a similar value. As the system runs, the NTC loses resistance and allows the current to reach a peak of 24mA. Figure 7 shows the overall effect of an NTC upon current inrush. As the graph shows, an unprotected system will have a large current & power inrush that drops the magnitude in accordance to the capacitor charge equation previously shown. With an NTC, the thermistor will absorb power as a function of time($t=0$), giving the system a manageable state.

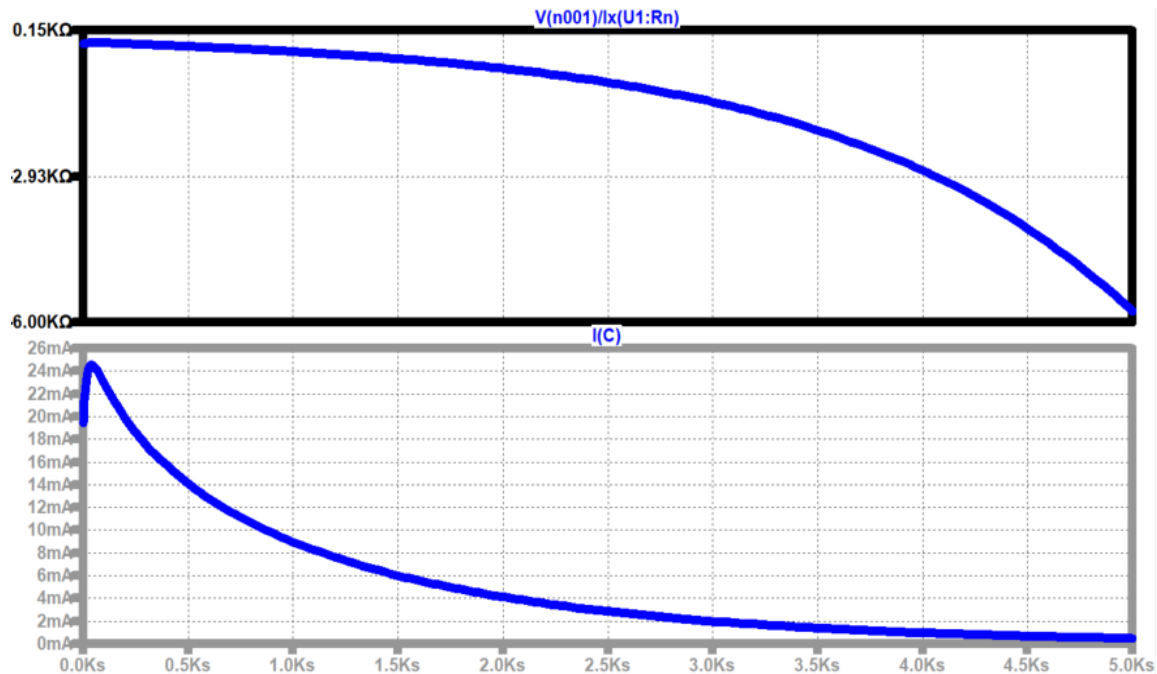

Figure 6: Side by Side view of supercapacitor's current and NTC resistance in a 10F supercapacitor and $R_{150@25c}$ NTC system

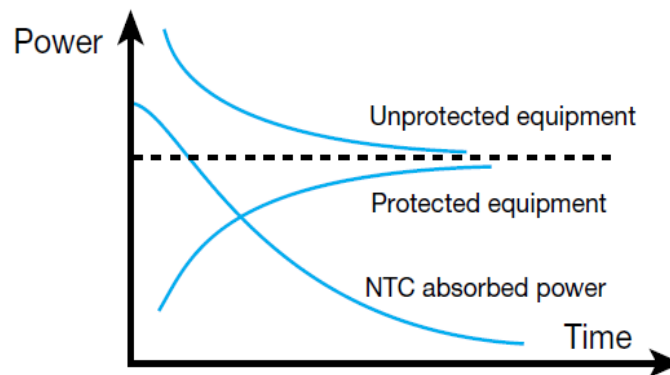

Figure 7: The overall effect of an NTC upon current inrush.

When designing a system with an NTC there are a few considerations to take into account. The first is the power rating and surge. The NTC's power rating must be greater than the surge or else the system will fail. The second is the thermal mass of the NTC and response time. The size of the NTC will affect how long it takes to charge the capacitor. If a large NTC is needed, the response time will increase. Even though the NTC is more efficient than a fixed resistor, and it has a lesser power loss, there are some disadvantages. For an example, since the NTC depends on temperature, it can be difficult to design an NTC into an application with multiple temperatures in addition to 25°C. Another drawback of an NTC is

its cool off time. After a NTC has heated up, it needs to be removed from the source in order to return to room temperature and high resistance. If it is not restored back to room temperature, it will not work to limit the current. Its resistance value will already be low; which will allow for high currents to flow into the capacitor. For this reason, NTCs are not recommended to be used on applications with a high cycling rate.

Passive Charge Control	Pro	Con
Fixed Resistor	<ul style="list-style-type: none"> • Easy to implement calculations • Single component solution • Lowest cost solution 	<ul style="list-style-type: none"> • Always Dissipating Energy • Physically large when dealing with large currents • Unstable temperatures
NTC	<ul style="list-style-type: none"> • Fast • Small • Inexpensive • Sensitivity • Protectionary fast response time 	<ul style="list-style-type: none"> • Not suitable for large temperature ranges • Not suitable for applications with high number cycle • Uncontrollable • Self-heating • Heat Dissipation

Table 2: Pros and cons for a fixed resistor and an NTC

Active Charge Control Method: MOSFET VS Integrated Circuit

MOSFET

The most simple active charge control makes use of MOSFETs. MOSFETs work very efficiently at low voltages and have virtually no current draw- thus they are low power devices. However, precautions must be taken to protect these devices from transient voltages during manufacturing, assembly, and operation. Additionally, MOSFETs are susceptible to steady state over voltage exposure. MOSFETs work very efficiently when designed with proper caution. Figure 8 is a schematic showing the fundamental implementation of a p-channel MOSFET using a low voltage gate driver controller. The charge circuit is broken up into two sections- a load switch (Q2; p-channel MOSFET), and a gate control (Q1; n-channel MOSFET). The control FET can utilize low voltage control signals to effect slew rate of the load switch. This circuit is based upon the fact that a small ‘control’ signal to the gate of the load switch MOSFET (Q2) can easily and accurately control the current delivered to a large supercapacitor. The disadvantage of this configuration is the need of an added MOSFET and passive components. Added components increase cost, size and weight to the circuit, but in many cases, any perceived disadvantages are outweighed by control accuracy and improved system reliability.

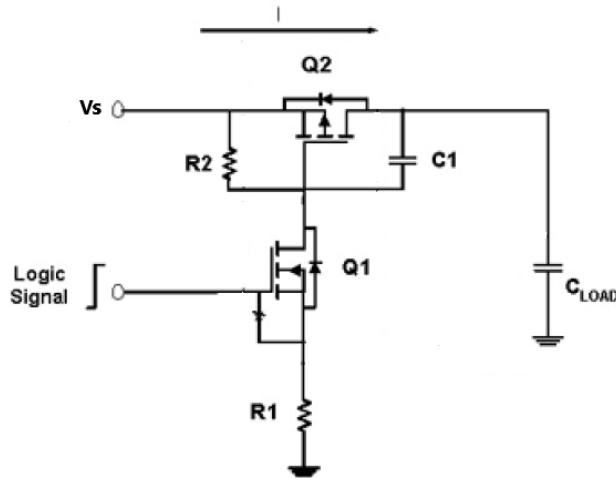

Figure 8: Typical integrated load switch using a MOSFET driver

Integrated Circuit

IC chipsets used in conjunction with supercapacitors generally offer features grouped into:

- Cell Balance Control
- Current Control
- Balance Control & Overvoltage Protection
- Back-Up & Voltage Regulation

Charge control chipsets use elaborate and comprehensive active charge control methods to perform Constant Current and Constant Voltage (CC/CV) charging, with programmable input current limits. See Figure 9 below. Many controller ICs come with built in voltage regulation, monitoring and multi-cell balancing when implementing a stack of supercapacitors. When implementing a stack or bank of supercapacitors, it is critical to have a balancing circuit on the supercapacitor stack that is purchased or an IC that provides active balancing.

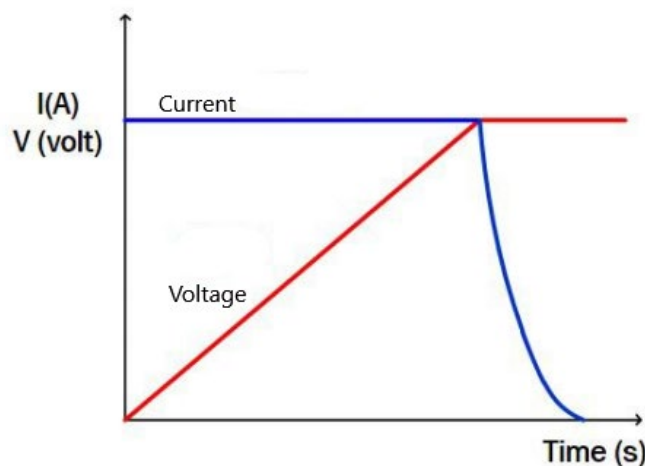

Figure 9: Constant current/constant voltage supercapacitor charge control

Supercapacitor reliability and life are highly dependent on operating voltage e.g. derating the voltage by 0.1V of a 2.7V rated part, can extend the life of a component by a factor of 2. Making the use of a CC/CV charging IC with stack voltage regulation and monitoring removes much of the heavy lifting and board space for an equivalent discrete solution, but comes at a premium and sometimes limits the number of supercapacitors that can be balanced and monitored. For more information on balancing any orientation or number of supercapacitors, please contact AVX.

Active Charge Control	Pro	Con
MOSFET	<ul style="list-style-type: none"> • More efficient than passive charge control methods • Easy to control gate voltage 	<ul style="list-style-type: none"> • Sensitive to transients • Charge control circuit can be large
IC	<ul style="list-style-type: none"> • Most efficient • Supercap stack monitoring and voltage regulation 	<ul style="list-style-type: none"> • Complex • Expensive

Table 3. Pros and cons for a MOSFET and IC chipset

Conclusion

A high-level comparison of passive and active supercapacitor charging control methods emphasizes the need for a close inspection on power source and supercapacitor demands. The emphasis to consider supercapacitor demands continues to grow as capacitance values increase and supercapacitor ESRs drop. Uncontrolled charging of an uncharged supercapacitor can result in the power supply experiencing near short conditions. The resulting dV/dt across charge supply semiconductors can either; create permanent damage or a transient upset due to the voltage droop on critical power lines of the system. Multiple combinations of efficient and complex charge control schemes exist that work across the spectrum of cost, size/weight and performance sensitive circuits.